

12-BIT, DUAL, ULTRALOW GLITCH, VOLTAGE OUTPUT DIGITAL-TO-ANALOG CONVERTER

FEATURES

- 2.7-V to 5.5-V Single Supply
- 12-Bit Linearity and Monotonicity
- Rail-to-Rail Voltage Output
- Settling Time: 5 μ s (Max)
- Ultralow Glitch Energy: 0.1 nVs
- Ultralow Crosstalk: -100 dB
- Low Power: 440 μ A (Max)
- Per-Channel Power Down: 2 μ A (Max)
- Power-On Reset to Midscale
- 2s Complement Input Data Format
- SPI-Compatible Serial Interface: Up to 50 MHz
- Daisy-Chain Capability
- Asynchronous Hardware Clear
- Simultaneous or Sequential Update
- Specified Temperature Range: -40°C to 105°C
- Small 3-mm x 3-mm, 16-Lead QFN Package

APPLICATIONS

- Portable Battery-Powered Instruments
- Digital Gain and Offset Adjustment
- Programmable Voltage and Current Sources
- Programmable Attenuators
- Industrial Process Control

DESCRIPTION

The DAC7553 is a 12-bit, dual-channel, voltage-output DAC with exceptional linearity and monotonicity. Its proprietary architecture minimizes undesired transients such as code-to-code glitch and channel-to-channel crosstalk. The low-power DAC7553 operates from a single 2.7-V to 5.5-V supply. The DAC7553 output amplifiers can drive a 2-k Ω , 200-pF load rail-to-rail with 5- μ s settling time; the output range is set using an external voltage reference.

The 3-wire serial interface operates at clock rates up to 50 MHz and is compatible with SPI, QSPI, Microwire™, and DSP interface standards. The outputs of all DACs may be updated simultaneously or sequentially. The parts incorporate a power-on-reset circuit to ensure that the DAC outputs power up at midscale and remain there until a valid write cycle to the device takes place. The parts contain a power-down feature that reduces the current consumption of the device to under 2 μ A.

The small size and low-power operation makes the DAC7553 ideally suited for battery-operated portable applications. The power consumption is typically 1.5 mW at 5 V, 0.75 mW at 3 V, and reduces to 1 μ W in power-down mode.

The DAC7553 is available in a 16-lead QFN package and is specified over -40°C to 105°C .

FUNCTIONAL BLOCK DIAGRAM

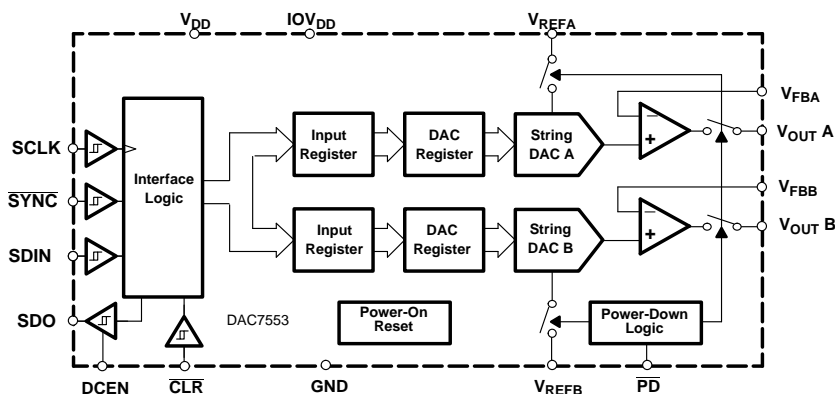

Please be aware that an important notice concerning availability, standard warranty, and use in critical applications of Texas Instruments semiconductor products and disclaimers thereto appears at the end of this data sheet.

Microwire is a trademark of National Semiconductor Corp..



This integrated circuit can be damaged by ESD. Texas Instruments recommends that all integrated circuits be handled with appropriate precautions. Failure to observe proper handling and installation procedures can cause damage.

ESD damage can range from subtle performance degradation to complete device failure. Precision integrated circuits may be more susceptible to damage because very small parametric changes could cause the device not to meet its published specifications.

ORDERING INFORMATION⁽¹⁾

PRODUCT	PACKAGE	PACKAGE DESIGNATOR	SPECIFIED TEMPERATURE RANGE	PACKAGE MARKING	ORDERING NUMBER	TRANSPORT MEDIA
DAC7553	16 QFN	RGT	–40°C TO 105°C	D753	DAC7553IRGTT	250-piece Tape and Reel
					DAC7553IRGTR	2500-piece Tape and Reel

(1) For the most current package and ordering information, see the Package Option Addendum at the end of this document, or see the TI Web site at www.ti.com.

ABSOLUTE MAXIMUM RATINGS

over operating free-air temperature range (unless otherwise noted)⁽¹⁾

	UNIT
V_{DD} to GND	–0.3 V to 6 V
Digital input voltage to GND	–0.3 V to $V_{DD} + 0.3$ V
V_{out} to GND	–0.3 V to $V_{DD} + 0.3$ V
Operating temperature range	–40°C to 105°C
Storage temperature range	–65°C to 150°C
Junction temperature (T_J Max)	150°C

(1) Stresses above those listed under “Absolute Maximum Ratings” may cause permanent damage to the device. Exposure to absolute maximum conditions for extended periods may affect device reliability.

ELECTRICAL CHARACTERISTICS
 $V_{DD} = 2.7\text{ V to }5.5\text{ V}$, $V_{REF} = V_{DD}$, $R_L = 2\text{ k}\Omega$ to GND; $C_L = 200\text{ pF}$ to GND; all specifications -40°C to 105°C , unless otherwise specified

PARAMETER	TEST CONDITIONS	MIN	TYP	MAX	UNITS
STATIC PERFORMANCE⁽¹⁾					
Resolution			12		Bits
Relative accuracy			± 0.35	± 1	LSB
Differential nonlinearity	Specified monotonic by design		± 0.08	± 0.5	LSB
Offset error				± 12	mV
Zero-scale error	All zeroes loaded to DAC register			± 12	mV
Gain error				± 0.15	%FSR
Full-scale error				± 0.5	%FSR
Zero-scale error drift			7		$\mu\text{V}/^\circ\text{C}$
Gain temperature coefficient			3		ppm of FSR/ $^\circ\text{C}$
PSRR	$V_{DD} = 5\text{ V}$		0.75		mV/V
OUTPUT CHARACTERISTICS⁽²⁾					
Output voltage range		0		V_{REF}	V
Output voltage settling time	$R_L = 2\text{ k}\Omega$; $0\text{ pF} < C_L < 200\text{ pF}$			5	μs
Slew rate			1.8		V/ μs
Capacitive load stability	$R_L = \infty$		470		pF
	$R_L = 2\text{ k}\Omega$		1000		
Digital-to-analog glitch impulse	1 LSB change around major carry		0.1		nV-s
Channel-to-channel crosstalk	1-kHz full-scale sine wave, outputs unloaded		-100		dB
Digital feedthrough			0.1		nV-s
Output noise density (10-kHz offset frequency)			120		nV/ rtHz
Total harmonic distortion	$F_{OUT} = 1\text{ kHz}$, $F_S = 1\text{ MSPS}$, $BW = 20\text{ kHz}$		-85		dB
DC output impedance			1		Ω
Short-circuit current	$V_{DD} = 5\text{ V}$		50		mA
	$V_{DD} = 3\text{ V}$		20		
Power-up time	Coming out of power-down mode, $V_{DD} = 5\text{ V}$		15		μs
	Coming out of power-down mode, $V_{DD} = 3\text{ V}$		15		
REFERENCE INPUT					
V_{REF} Input range		0		V_{DD}	V
Reference input impedance	V_{REFA} and V_{REFB} shorted together		50		k Ω
Reference current	$V_{REFA} = V_{REFB} = V_{DD} = 5\text{ V}$, V_{REFA} and V_{REFB} shorted together		100	250	μA
	$V_{REFA} = V_{REFB} = V_{DD} = 3\text{ V}$, V_{REFA} and V_{REFB} shorted together		60	123	
LOGIC INPUTS⁽²⁾					
Input current				± 1	μA
V_{IN_L} , Input low voltage	$IOV_{DD} \geq 2.7\text{ V}$			$0.3\text{ }IOV_{DD}$	V
V_{IN_H} , Input high voltage	$IOV_{DD} \geq 2.7\text{ V}$	$0.7\text{ }IOV_{DD}$			V
Pin capacitance				3	pF

(1) Linearity tested using a reduced code range of 30 to 4065; output unloaded.

(2) Specified by design and characterization, not production tested. For $1.8\text{ V} < IOV_{DD} < 2.7\text{ V}$, It is recommended that $V_{IH} = IOV_{DD}$, $V_{IL} = \text{GND}$.

ELECTRICAL CHARACTERISTICS (continued)

$V_{DD} = 2.7\text{ V to }5.5\text{ V}$, $V_{REF} = V_{DD}$, $R_L = 2\text{ k}\Omega$ to GND; $C_L = 200\text{ pF}$ to GND; all specifications -40°C to 105°C , unless otherwise specified

PARAMETER	TEST CONDITIONS	MIN	TYP	MAX	UNITS
POWER REQUIREMENTS					
$V_{DD}, IOV_{DD}^{(3)}$		2.7		5.5	V
I_{DD} (normal operation)	DAC active and excluding load current				
$V_{DD} = 3.6\text{ V to }5.5\text{ V}$	$V_{IH} = IOV_{DD}$ and $V_{IL} = \text{GND}$		300	440	μA
$V_{DD} = 2.7\text{ V to }3.6\text{ V}$			250	400	
I_{DD} (all power-down modes)	$V_{IH} = IOV_{DD}$ and $V_{IL} = \text{GND}$				
$V_{DD} = 3.6\text{ V to }5.5\text{ V}$			0.2	2	μA
$V_{DD} = 2.7\text{ V to }3.6\text{ V}$			0.05	2	
POWER EFFICIENCY					
I_{OUT}/I_{DD}	$I_{LOAD} = 2\text{ mA}$, $V_{DD} = 5\text{ V}$		93%		

(3) IOV_{DD} operates down to 1.8 V with slightly degraded timing, as long as $V_{IH} = IOV_{DD}$ and $V_{IL} = \text{GND}$.

TIMING CHARACTERISTICS⁽¹⁾⁽²⁾

$V_{DD} = 2.7\text{ V to }5.5\text{ V}$, $R_L = 2\text{ k}\Omega$ to GND; all specifications $-40^\circ\text{C to }105^\circ\text{C}$, unless otherwise specified

PARAMETER		TEST CONDITIONS	MIN	TYP	MAX	UNITS
$t_1^{(3)}$	SCLK cycle time	$V_{DD} = 2.7\text{ V to }3.6\text{ V}$	20			ns
		$V_{DD} = 3.6\text{ V to }5.5\text{ V}$	20			
t_2	SCLK HIGH time	$V_{DD} = 2.7\text{ V to }3.6\text{ V}$	10			ns
		$V_{DD} = 3.6\text{ V to }5.5\text{ V}$	10			
t_3	SCLK LOW time	$V_{DD} = 2.7\text{ V to }3.6\text{ V}$	10			ns
		$V_{DD} = 3.6\text{ V to }5.5\text{ V}$	10			
t_4	$\overline{\text{SYNC}}$ falling edge to SCLK falling edge setup time	$V_{DD} = 2.7\text{ V to }3.6\text{ V}$	4			ns
		$V_{DD} = 3.6\text{ V to }5.5\text{ V}$	4			
t_5	Data setup time	$V_{DD} = 2.7\text{ V to }3.6\text{ V}$	5			ns
		$V_{DD} = 3.6\text{ V to }5.5\text{ V}$	5			
t_6	Data hold time	$V_{DD} = 2.7\text{ V to }3.6\text{ V}$	4.5			ns
		$V_{DD} = 3.6\text{ V to }5.5\text{ V}$	4.5			
t_7	SCLK falling edge to $\overline{\text{SYNC}}$ rising edge	$V_{DD} = 2.7\text{ V to }3.6\text{ V}$	0			ns
		$V_{DD} = 3.6\text{ V to }5.5\text{ V}$	0			
t_8	Minimum $\overline{\text{SYNC}}$ HIGH time	$V_{DD} = 2.7\text{ V to }3.6\text{ V}$	20			ns
		$V_{DD} = 3.6\text{ V to }5.5\text{ V}$	20			
t_9	SCLK falling edge to SDO valid	$V_{DD} = 2.7\text{ V to }3.6\text{ V}$	10			ns
		$V_{DD} = 3.6\text{ V to }5.5\text{ V}$	10			
t_{10}	$\overline{\text{CLR}}$ pulse width low	$V_{DD} = 2.7\text{ V to }3.6\text{ V}$	10			ns
		$V_{DD} = 3.6\text{ V to }5.5\text{ V}$	10			

(1) All input signals are specified with $t_R = t_F = 1\text{ ns}$ (10% to 90% of V_{DD}) and timed from a voltage level of $(V_{IL} + V_{IH})/2$.

(2) See Serial Write Operation timing diagram [Figure 1](#).

(3) Maximum SCLK frequency is 50 MHz at $V_{DD} = 2.7\text{ V to }5.5\text{ V}$.

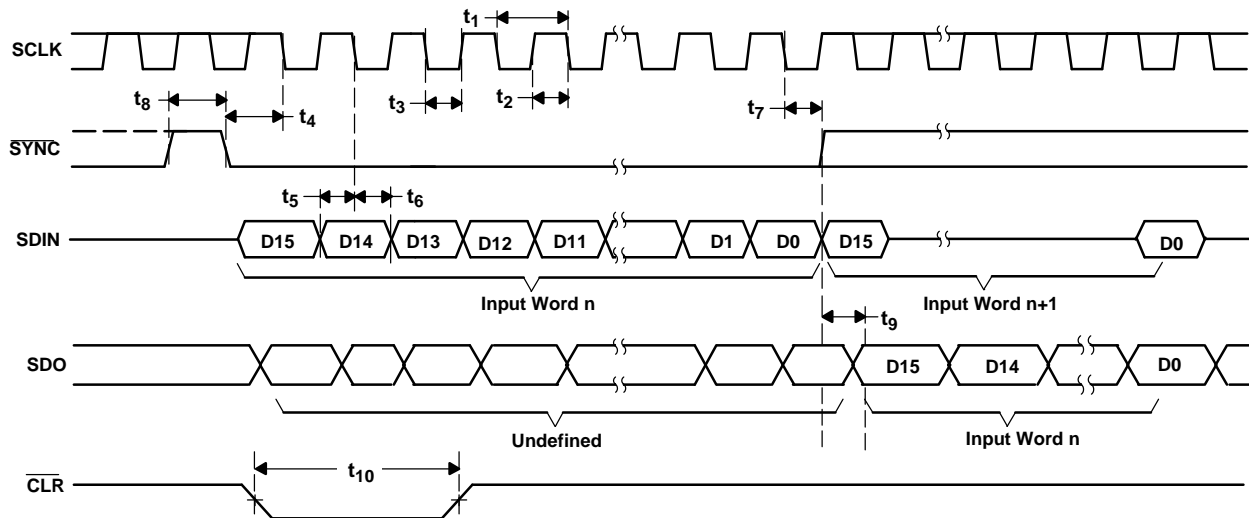
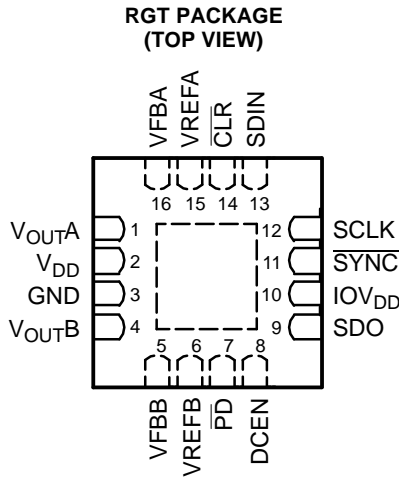

Figure 1. Serial Write Operation

PIN DESCRIPTION



Terminal Functions

TERMINAL		DESCRIPTION
NO.	NAME	
1	VOUTA	Analog output voltage from DAC A
2	VDD	Analog voltage supply input
3	GND	Ground
4	VOUTB	Analog output voltage from DAC B
5	VFBB	DAC B amplifier sense input.
6	VREFB	Positive reference voltage input for DAC B
7	\overline{PD}	Power down
8	DCEN	Daisy-chain enable
9	SDO	Serial data output
10	IOVDD	I/O voltage supply input
11	\overline{SYNC}	Frame synchronization input. The falling edge of the \overline{SYNC} pulse indicates the start of a serial data frame shifted out to the DAC7553
12	SCLK	Serial clock input
13	SDIN	Serial data input
14	\overline{CLR}	Asynchronous input to clear the DAC registers. When \overline{CLR} is low, the DAC registers are set to 000H and the output to midscale voltage.
15	VREFA	Positive reference voltage input for DAC A
16	VFBA	DAC A amplifier sense input.

TYPICAL CHARACTERISTICS

**LINEARITY ERROR AND
DIFFERENTIAL LINEARITY ERROR
VS
DIGITAL INPUT CODE**

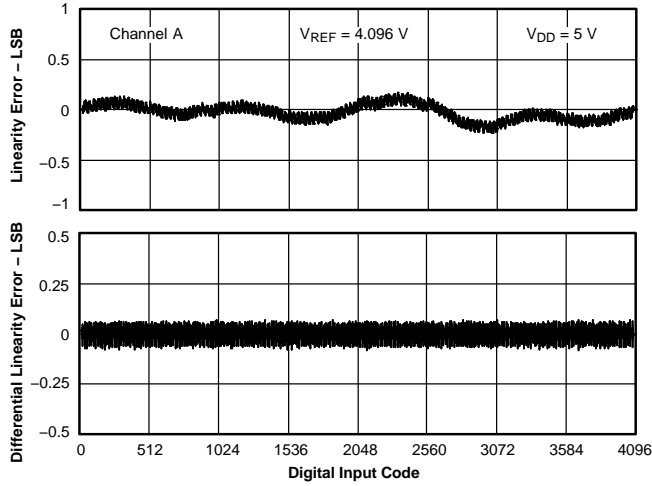

Figure 2.

**LINEARITY ERROR AND
DIFFERENTIAL LINEARITY ERROR
VS
DIGITAL INPUT CODE**

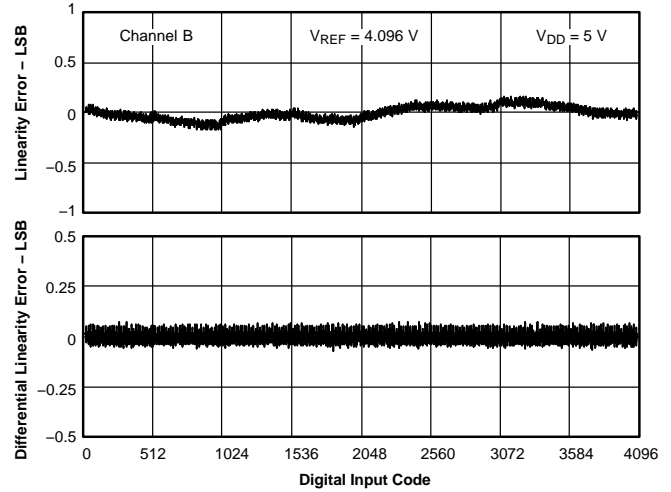

Figure 3.

**LINEARITY ERROR AND
DIFFERENTIAL LINEARITY ERROR
VS
DIGITAL INPUT CODE**

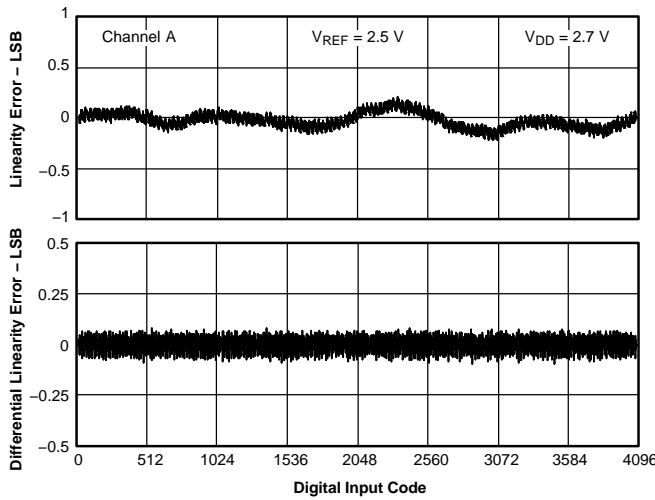

Figure 4.

**LINEARITY ERROR AND
DIFFERENTIAL LINEARITY ERROR
VS
DIGITAL INPUT CODE**

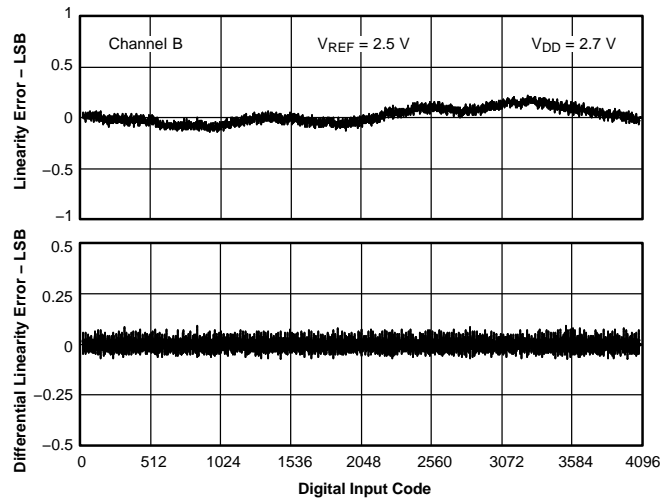

Figure 5.

TYPICAL CHARACTERISTICS (continued)

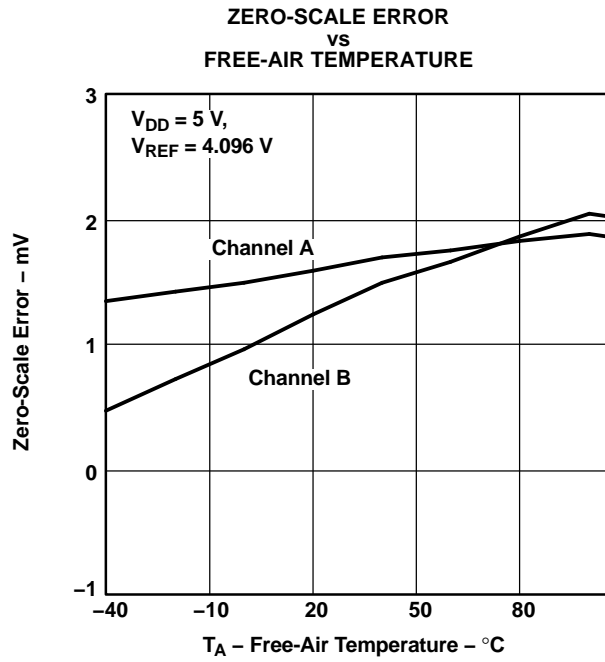

Figure 6.

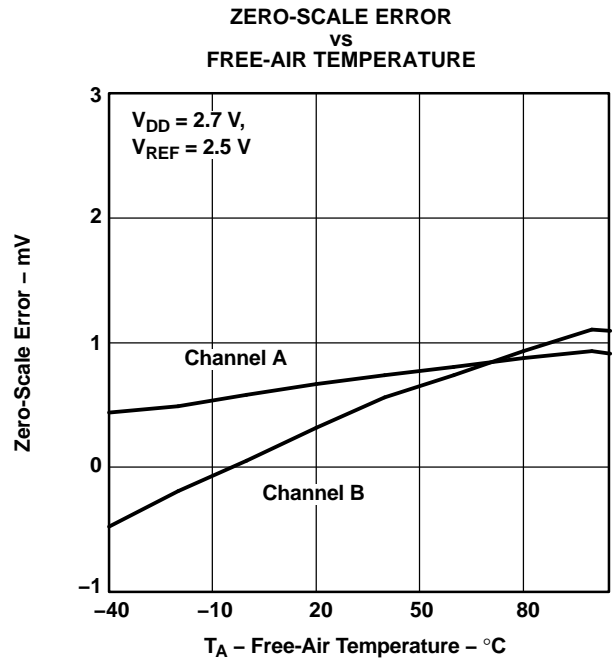

Figure 7.

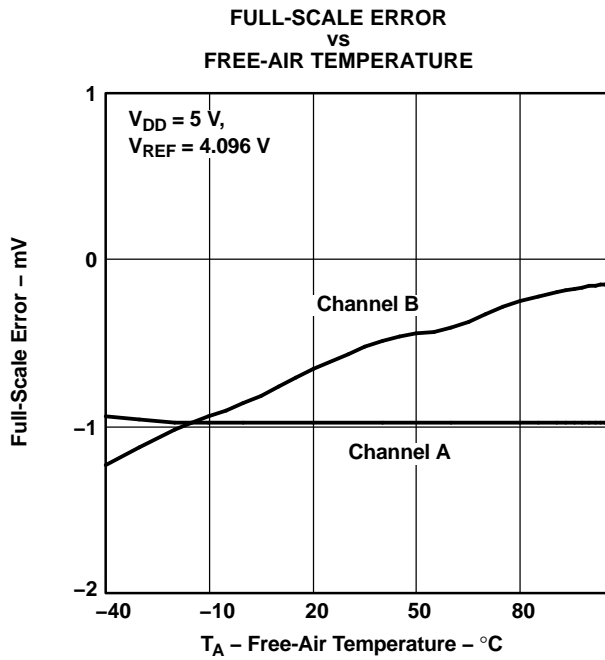

Figure 8.

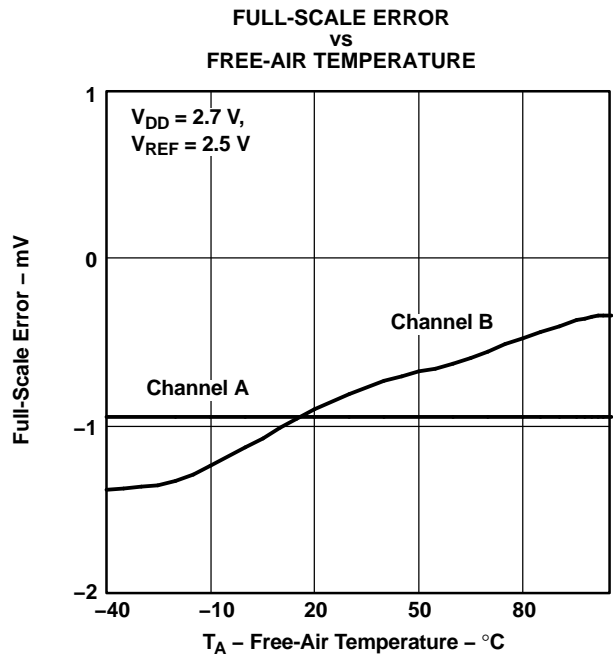

Figure 9.

TYPICAL CHARACTERISTICS (continued)

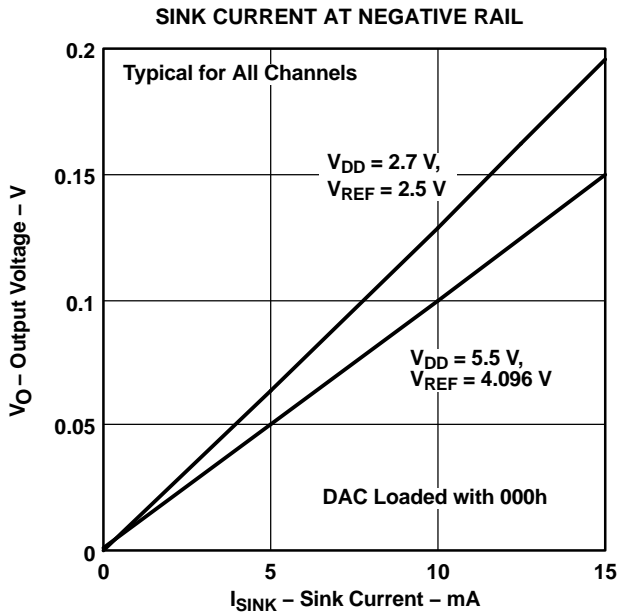

Figure 10.

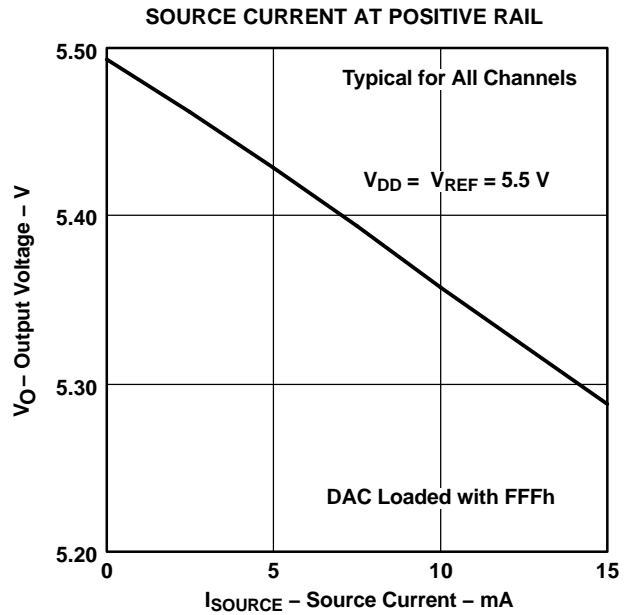

Figure 11.

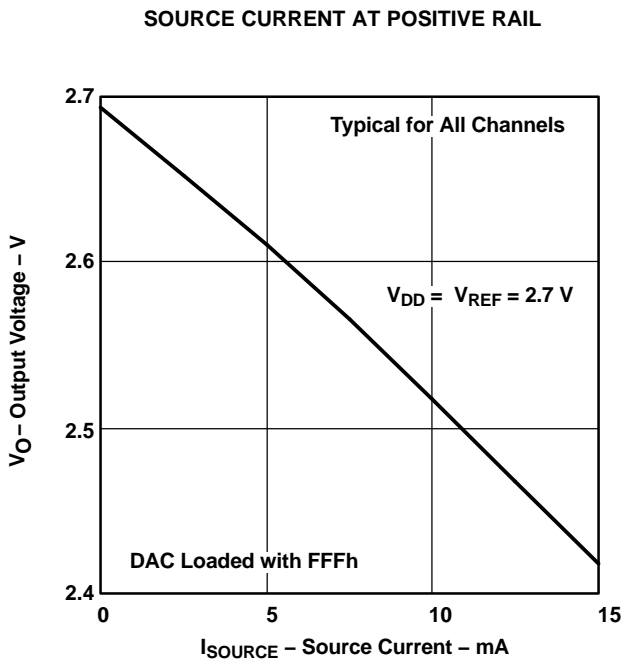

Figure 12.

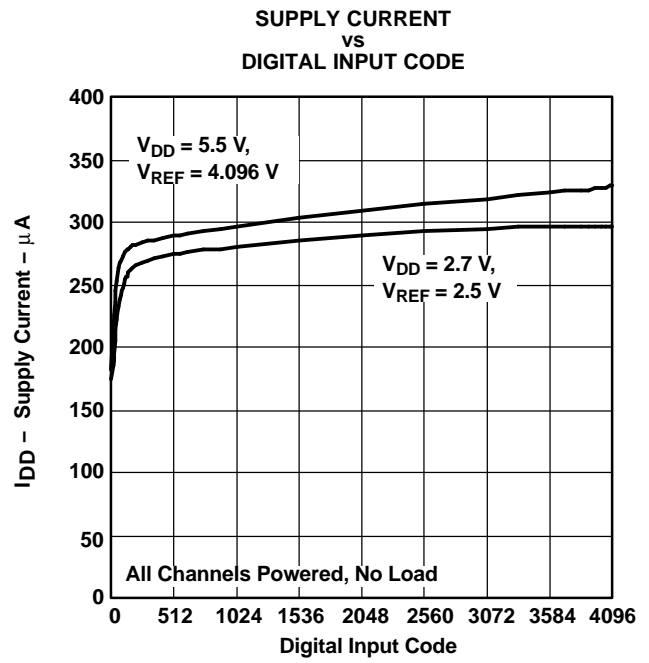

Figure 13.

TYPICAL CHARACTERISTICS (continued)

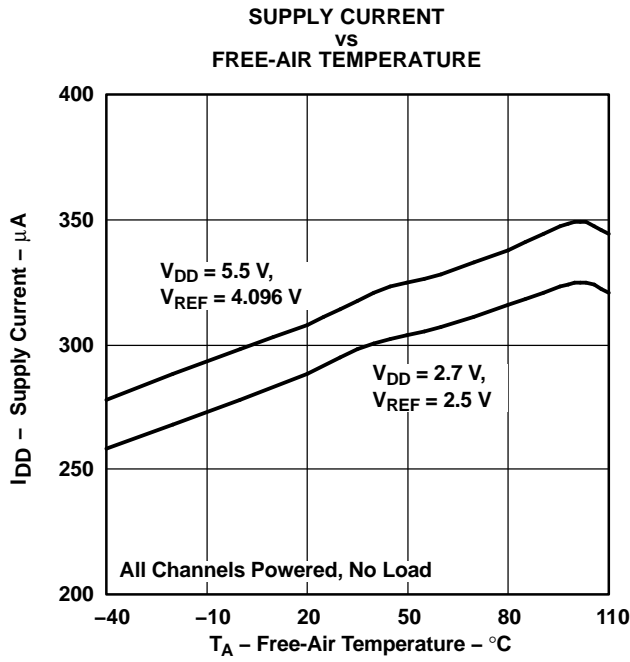

Figure 14.

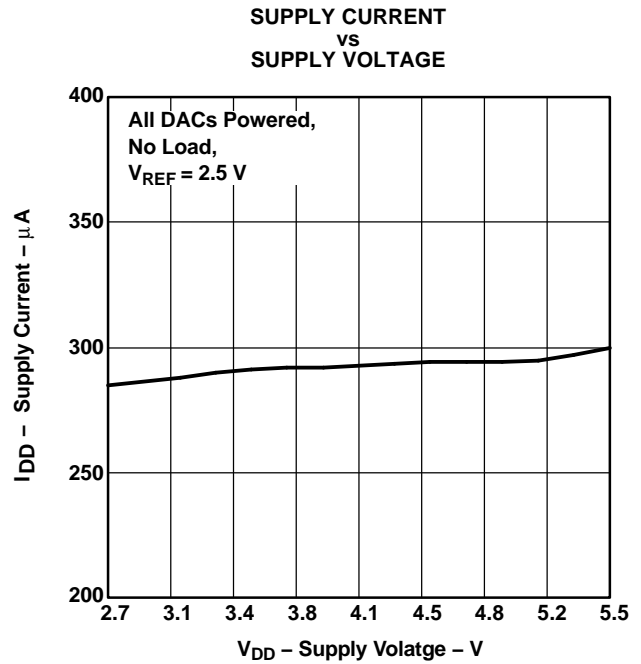

Figure 15.

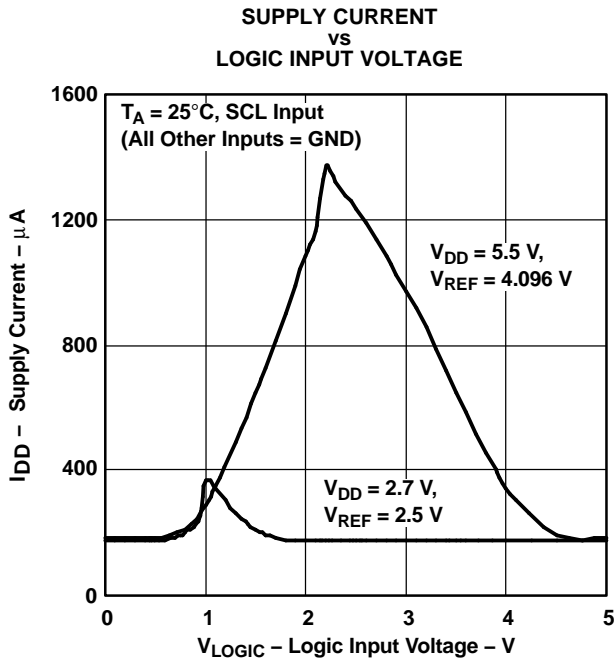

Figure 16.

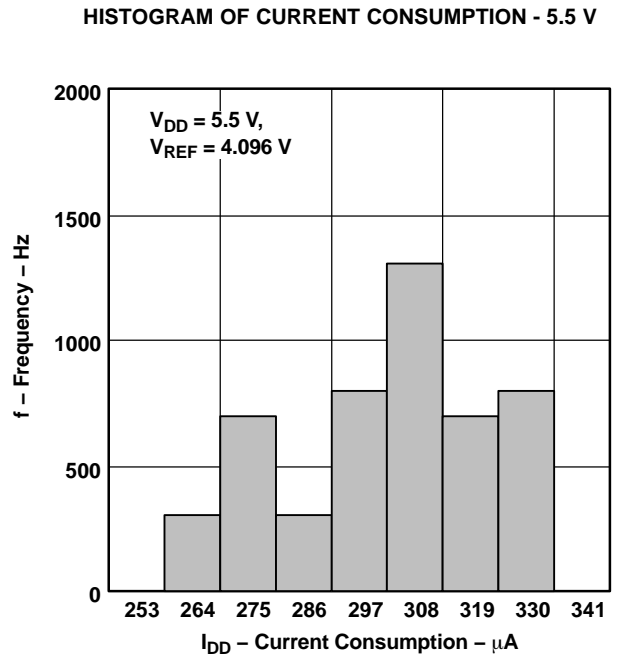

Figure 17.

TYPICAL CHARACTERISTICS (continued)

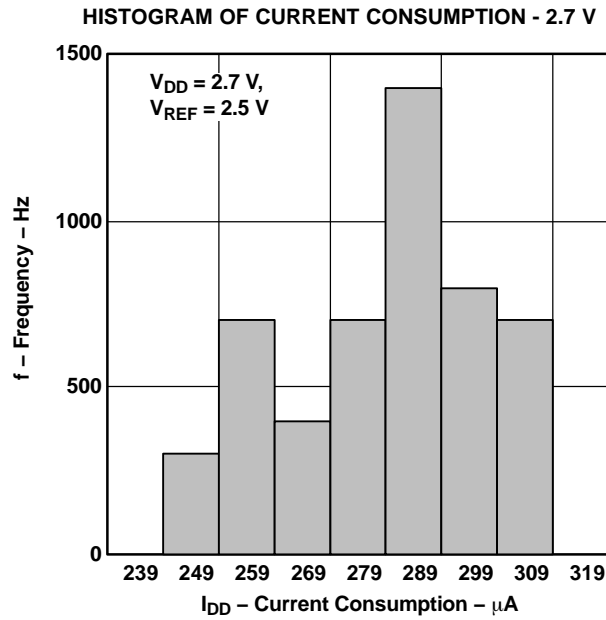

Figure 18.

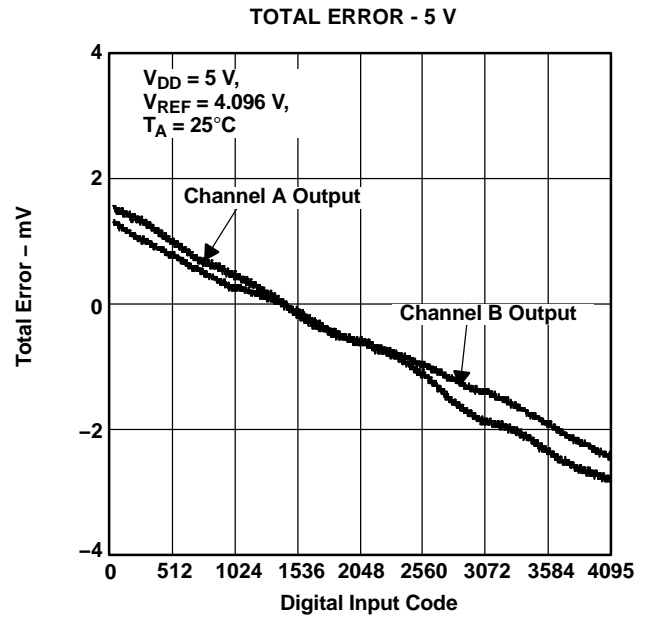

Figure 19.

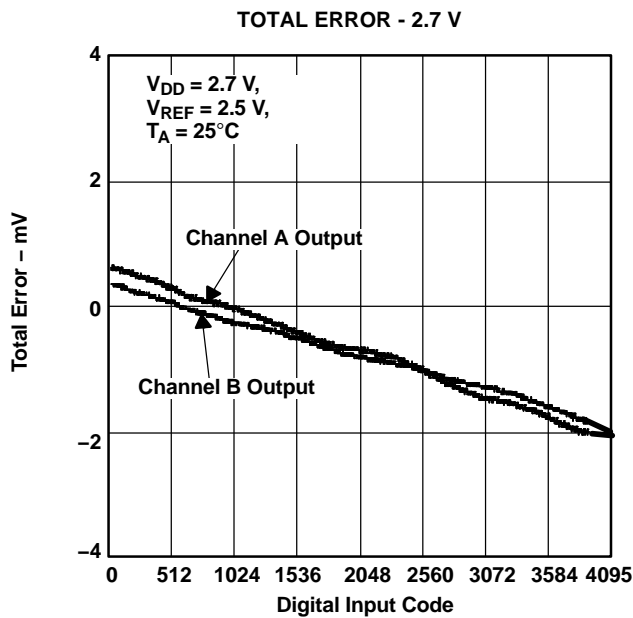

Figure 20.

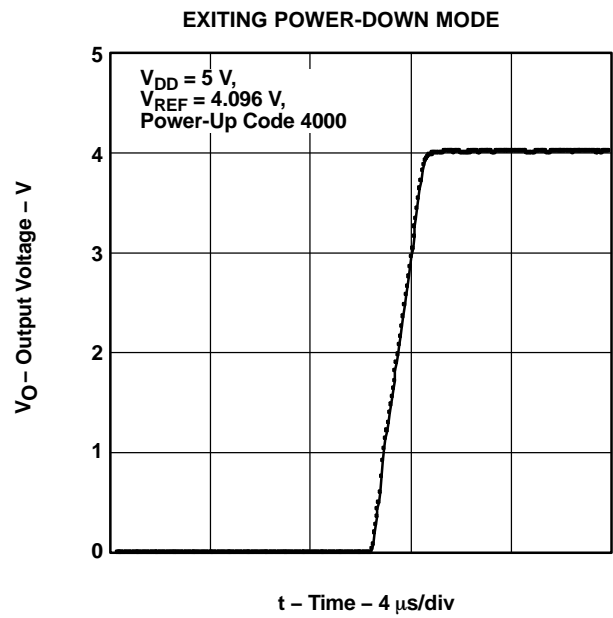

Figure 21.

TYPICAL CHARACTERISTICS (continued)

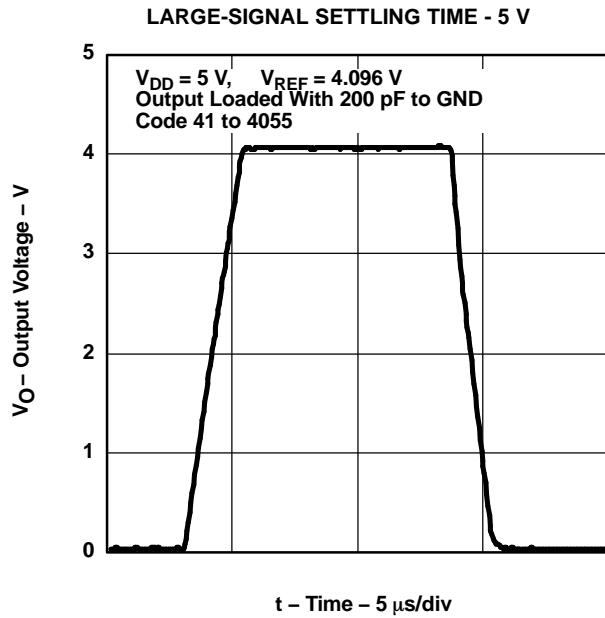

Figure 22.

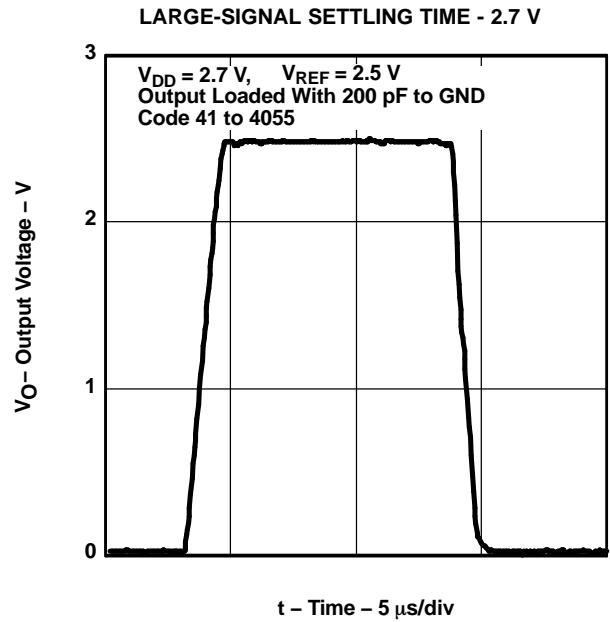

Figure 23.

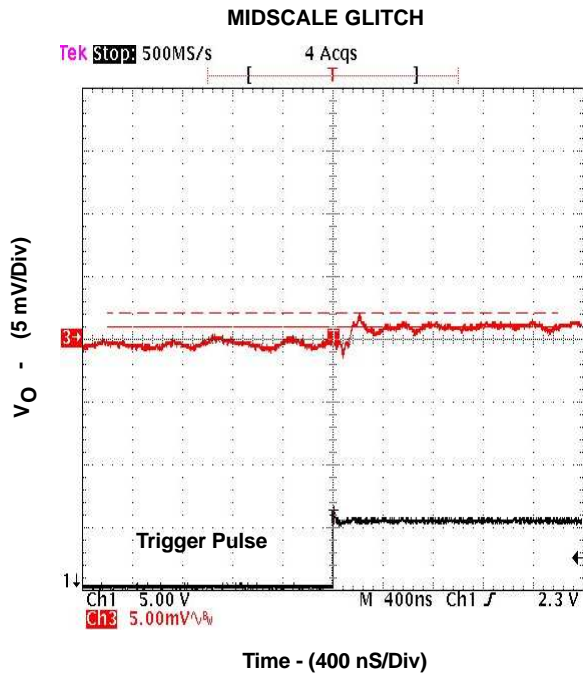

Figure 24.

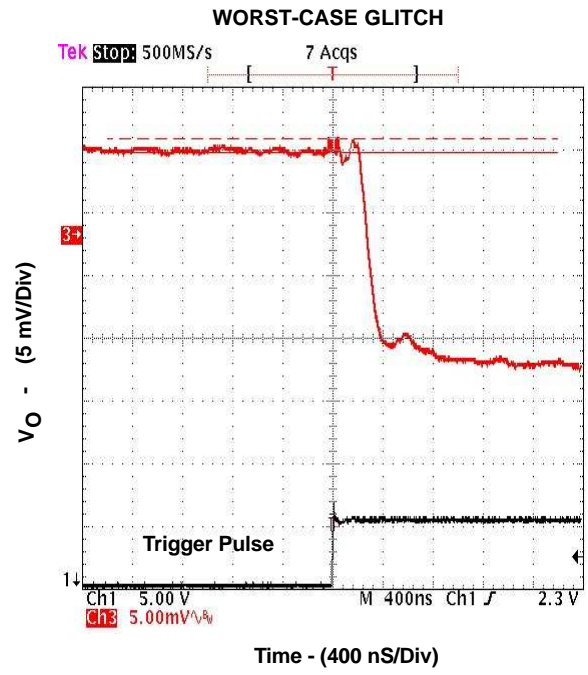

Figure 25.

TYPICAL CHARACTERISTICS (continued)

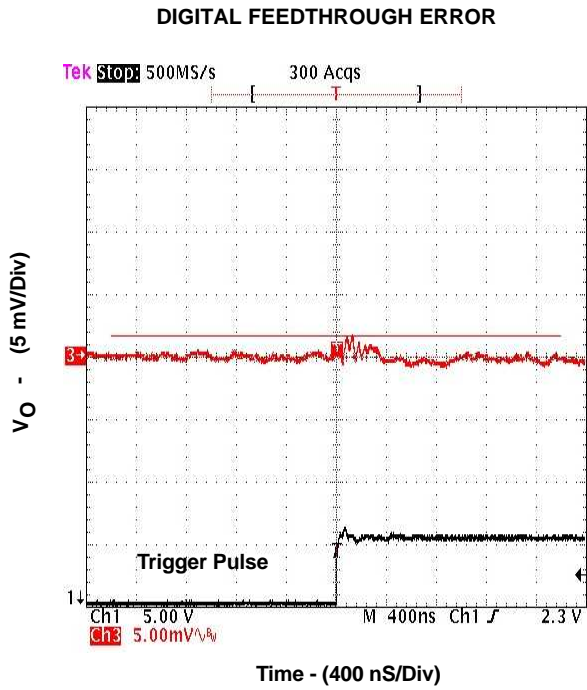

Figure 26.

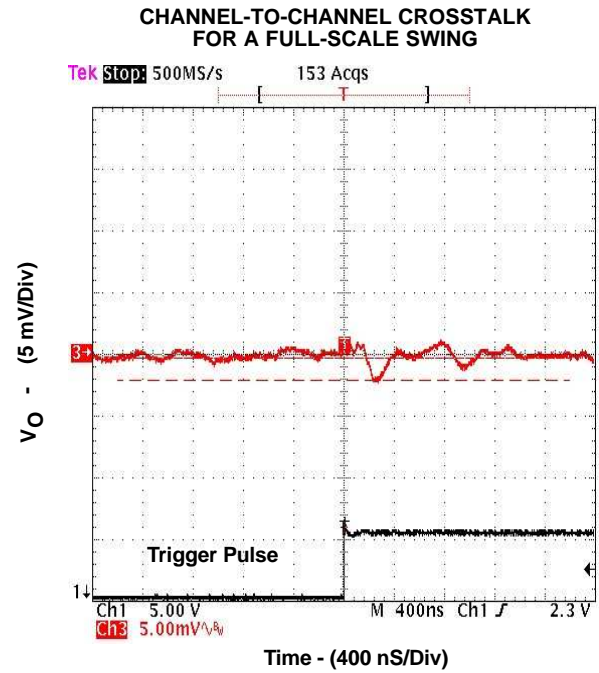

Figure 27.

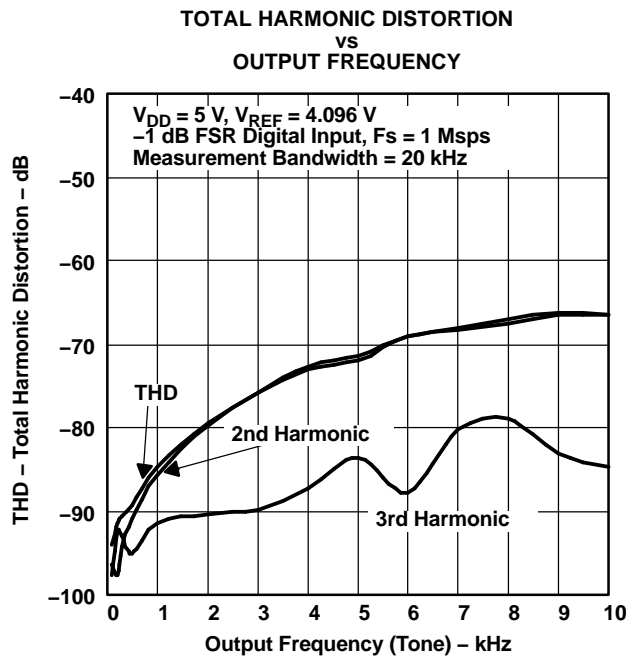

Figure 28.

TYPICAL CHARACTERISTICS (continued)

3-Wire Serial Interface

The DAC7553 digital interface is a standard 3-wire SPI/QSPI/Microwire/DSP-compatible interface.

Table 1. Serial Interface Programming

CONTROL				DATA BITS	DAC(s)	FUNCTION
DB15	DB14	DB13	DB12	DB11-DB10		
0	0	0	0	data	A	Single Channel Store. The TMP register of channel A is updated.
0	0	1	0	data	B	Single Channel Store. The TMP register of channel B is updated.
0	1	0	0	data	A	Single Channel Update. The TMP and DAC registers of channel A are updated.
0	1	1	0	data	B	Single Channel Update. The TMP and DAC registers of channel A are updated and the DAC register of channel B is updated with input register data.
1	0	0	0	data	A	Single Channel Update. The TMP and DAC registers of channel B are updated.
1	0	1	0	data	B	Single Channel Update. The TMP and DAC registers of channel B are updated and the DAC register of channel A is updated with input register data.
1	1	0	0	data	A–B	All Channel Update. The TMP and DAC registers of channels A and B are updated.
1	1	1	0	data	A–B	All Channel DAC Update. The DAC register of channels A and B are updated with input register data.

POWER-DOWN MODE

In power-down mode, the DAC outputs are programmed to one of three output impedances, 1 kΩ, 100 kΩ, or floating.

Table 2. Power-Down Mode Control

EXTENDED CONTROL				DATA BITS			FUNCTION
DB15	DB14	DB13	DB12	DB11	DB10	DB9-DB0	
0	0	X	1	0	0	X	PWD Hi-Z (all channels)
0	0	X	1	0	1	X	PWD 1 kΩ (all channels)
0	0	X	1	1	0	X	PWD 100 kΩ (all channels)
0	0	X	1	1	1	X	PWD Hi-Z (all channels)
0	1	X	1	0	0	X	PWD Hi-Z (selected channel = A)
0	1	X	1	0	1	X	PWD 1 kΩ (selected channel = A)
0	1	X	1	1	0	X	PWD 100 kΩ (selected channel = A)
0	1	X	1	1	1	X	PWD Hi-Z (selected channel = A)
1	0	X	1	0	0	X	PWD Hi-Z (selected channel = B)
1	0	X	1	0	1	X	PWD 1 kΩ (selected channel = B)
1	0	X	1	1	0	X	PWD 100 kΩ (selected channel = B)
1	0	X	1	1	1	X	PWD Hi-Z (selected channel = B)
1	1	X	1	0	0	X	PWD Hi-Z (all channels)
1	1	X	1	0	1	X	PWD 1 kΩ (all channels)
1	1	X	1	1	0	X	PWD 100 kΩ (all channels)
1	1	X	1	1	1	X	PWD Hi-Z (all channels)

THEORY OF OPERATION

D/A SECTION

The architecture of the DAC7553 consists of a string DAC followed by an output buffer amplifier. Figure 29 shows a generalized block diagram of the DAC architecture.

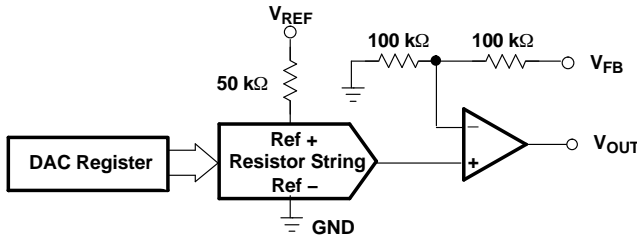

Figure 29. Typical DAC Architecture

The 2s-complement input coding to the DAC7553 gives the ideal output voltage as:

$$V_{OUT} = V_{REF} \times D/4096$$

Where D = decimal equivalent of the 2s-complement input that is loaded to the DAC register, which can range from 0 to 4095.

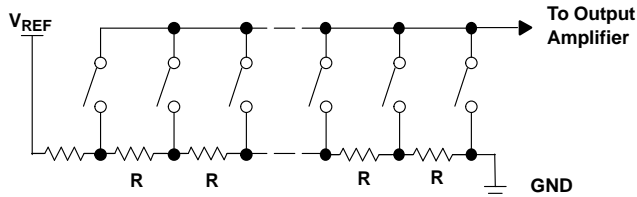

Figure 30. Typical Resistor String

RESISTOR STRING

The resistor string section is shown in Figure 30. It is simply a string of resistors, each of value R. The digital code loaded to the DAC register determines at which node on the string the voltage is tapped off to be fed into the output amplifier. The voltage is tapped off by closing one of the switches connecting the string to the amplifier. Because it is a string of resistors, it is specified monotonic. The DAC7553 architecture uses four separate resistor strings to minimize channel-to-channel crosstalk.

OUTPUT BUFFER AMPLIFIERS

The output buffer amplifier is capable of generating rail-to-rail voltages on its output, which gives an output range of 0 V to V_{DD} . It is capable of driving a load of 2 kΩ in parallel with up to 1000 pF to GND. The source and sink capabilities of the output amplifier can be seen in the typical curves. The slew rate is 1.8 V/μs with a typical settling time of 3 μs with the output unloaded.

DAC External Reference Input

Two separate reference pins are provided for two DACs, providing maximum flexibility. VREFA serves DAC A and VREFB serves DAC B. VREFA and VREFB can be externally shorted together for simplicity.

It is recommended to use a buffered reference in the external circuit (e.g., REF3140). The input impedance is typically 100 kΩ for each reference input pin.

Amplifier Sense Input

The DAC7553 contains two amplifier feedback input pins, VFBA and VFBB. For voltage output operation, VFBA and VFBB must externally connect to VOUTA and VOUTB, respectively. For better DC accuracy, these connections should be made at load points. The VFBA and VFBB pins are also useful for a variety of applications, including digitally controlled current sources. Each feedback input pin is internally connected to the DAC amplifier's negative input terminal through a 100-kΩ resistor; and, the amplifier's negative input terminal internally connects to ground through another 100-kΩ resistor (See Figure 29). This forms a gain-of-two, noninverting amplifier configuration. Overall gain remains one because the resistor string has a divide-by-two configuration. The resistance seen at each VFBA pin is approximately 200 kΩ to ground.

Power-On Reset

On power up, all internal registers are cleared and all channels are updated with midscale voltages. Until valid data is written, all DAC outputs remain in this state. This is particularly useful in applications where it is important to know the state of the DAC outputs while the device is powering up. In order not to turn on ESD protection devices, V_{DD} should be applied before any other pin is brought high.

Power Down

The DAC7553 has a flexible power-down capability as described in Table 2. Individual channels could be powered down separately or all channels could be powered down simultaneously. During a power-down condition, the user has flexibility to select the output impedance of each channel. During power-down operation, each channel can have either 1-k Ω , 100-k Ω , or Hi-Z output impedance to ground.

Asynchronous Clear

The DAC7553 output is asynchronously set to midscale voltage immediately after the $\overline{\text{CLR}}$ pin is brought low. The $\overline{\text{CLR}}$ signal resets all internal registers and therefore behaves like the Power-On Reset. The DAC7553 updates at the first rising edge of the SYNC signal that occurs after the $\overline{\text{CLR}}$ pin is brought back to high.

IOVDD and Level Shifters

The DAC7553 can be used with different logic families that require a wide range of supply voltages (from 1.8 V to 5.5 V). To enable this useful feature, the IOVDD pin must be connected to the logic supply voltage of the system. All DAC7553 digital input and output pins are equipped with level-shifter circuits. Level shifters at the input pins ensure that external logic high voltages are translated to the internal logic high voltage, with no additional power dissipation. Similarly, the level shifter for the SDO pin translates the internal logic high voltage (VDD) to the external logic high level (IOVDD). For single-supply operation, the IOVDD pin can be tied to the VDD pin.

SERIAL INTERFACE

The DAC7553 is controlled over a versatile 3-wire serial interface, which operates at clock rates up to 50 MHz and is compatible with SPI, QSPI, Microwire, and DSP interface standards.

In daisy-chain mode (DCEN = 1) the DAC7553 requires a falling SCLK edge after the rising $\overline{\text{SYNC}}$, in order to initialize the serial interface for the next update.

16-Bit Word and Input Shift Register

The input shift register is 16 bits wide. DAC data is loaded into the device as a 16-bit word under the control of a serial clock input, SCLK, as shown in Figure 1 timing diagram. The 16-bit word, illustrated in Table 1, consists of four control bits followed by 12 bits of DAC data. The 12-bit data is in 2s-complement format, with 800H corresponding to 0-V output and 7FFH corresponding to full-scale output ($V_{\text{REF}} - 1$ LSB). Data is loaded MSB first (Bit 15) where the first two bits (DB15 and DB14) determine if the input register, DAC register, or both are updated with shift

register input data. Bit 13 (DB13) determines whether the data is for DAC A, DAC B, or both DACs. Bit 12 (DB12) determines either normal mode or power-down mode (see Table 2). All channels are updated when bits 15 and 14 (DB15 and DB14) are high.

The $\overline{\text{SYNC}}$ input is a level-triggered input that acts as a frame synchronization signal and chip enable. Data can only be transferred into the device while $\overline{\text{SYNC}}$ is low. To start the serial data transfer, $\overline{\text{SYNC}}$ should be taken low, observing the minimum $\overline{\text{SYNC}}$ to SCLK falling edge setup time, t_4 . After $\overline{\text{SYNC}}$ goes low, serial data is shifted into the device's input shift register on the falling edges of SCLK for 16 clock pulses.

When DCEN is low, the SDO pin is brought to a Hi-Z state. The first 16 data bits that follow the falling edge of $\overline{\text{SYNC}}$ are stored in the shift register. The rising edge of $\overline{\text{SYNC}}$ that follows the 16th data bit updates the DAC(s). If $\overline{\text{SYNC}}$ is brought high before the 16th data bit, no action occurs.

When DCEN is high, data can continuously be shifted into the shift register, enabling the daisy-chain operation. The SDO pin becomes active and outputs SDIN data with 16 clock cycle delay. A rising edge of $\overline{\text{SYNC}}$ loads the shift register data into the DAC(s). The loaded data consists of the last 16 data bits received into the shift register before the rising edge of $\overline{\text{SYNC}}$.

If daisy-chain operation is not needed, DCEN should permanently be tied to a logic low voltage.

Daisy-Chain Operation

When DCEN pin is brought high, daisy chaining is enabled. The Serial Data Output (SDO) pin is provided to daisy-chain multiple DAC7553 devices in a system.

As long as $\overline{\text{SYNC}}$ is high or DCEN is low, the SDO pin is in a high-impedance state. When $\overline{\text{SYNC}}$ is brought low, the output of the internal shift register is tied to the SDO pin. As long as $\overline{\text{SYNC}}$ is low and DCEN is high, SDO duplicates the SDIN signal with a 16-cycle delay. To support multiple devices in a daisy chain, SCLK and $\overline{\text{SYNC}}$ signals are shared across all devices, and SDO of one DAC7553 should be tied to the SDIN of the next DAC7553. For n devices in such a daisy chain, $16n$ SCLK cycles are required to shift the entire input data stream. After $16n$ SCLK falling edges are received, following a falling $\overline{\text{SYNC}}$, the data stream becomes complete and $\overline{\text{SYNC}}$ can be brought high to update n devices simultaneously. SDO operation is specified at a maximum SCLK speed of 10 MHz.

INTEGRAL AND DIFFERENTIAL LINEARITY

The DAC7553 uses precision thin-film resistors providing exceptional linearity and monotonicity. Integral linearity error is typically within (+/-) 0.35 LSBs, and differential linearity error is typically within (+/-) 0.08 LSBs.

GLITCH ENERGY

The DAC7553 uses a proprietary architecture that minimizes glitch energy. The code-to-code glitches are so low, they are usually buried within the wide-band noise and cannot be easily detected. The DAC7553 glitch is typically well under 0.1 nV-s. Such low glitch energy provides more than 10X improvement over industry alternatives.

CHANNEL-TO-CHANNEL CROSSTALK

The DAC7553 architecture is designed to minimize channel-to-channel crosstalk. The voltage change in one channel does not affect the voltage output in another channel. The DC crosstalk is in the order of a few microvolts. AC crosstalk is also less than -100 dBs. This provides orders of magnitude improvement over certain competing architectures.

APPLICATION INFORMATION

Waveform Generation

Due to its exceptional linearity, low glitch, and low crosstalk, the DAC7553 is well suited for waveform generation (from DC to 10 kHz). The DAC7553 large-signal settling time is 5 μ s, supporting an update rate of 200 KSPS. However, the update rates can exceed 1 MSPS if the waveform to be generated consists of small voltage steps between consecutive DAC updates. To obtain a high dynamic range, REF3140 (4.096 V) or REF02 (5 V) are recommended for reference voltage generation.

Generating ± 5 -V, ± 10 -V, and ± 12 -V Outputs For Precision Industrial Control

Industrial control applications can require multiple feedback loops consisting of sensors, ADCs, MCUs, DACs, and actuators. Loop accuracy and loop speed are the two important parameters of such control loops.

Loop Accuracy:

In a control loop, the ADC has to be accurate. Offset, gain, and the integral linearity errors of the DAC are not factors in determining the accuracy of the loop. As long as a voltage exists in the transfer curve of a monotonic DAC, the loop can find it and settle to it. On the other hand, DAC resolution and differential linearity do determine the loop accuracy, because

each DAC step determines the minimum incremental change the loop can generate. A DNL error less than -1 LSB (non-monotonicity) can create loop instability. A DNL error greater than +1 LSB implies unnecessarily large voltage steps and missed voltage targets. With high DNL errors, the loop loses its stability, resolution, and accuracy. Offering 12-bit ensured monotonicity and ± 0.08 LSB typical DNL error, 755X DACs are great choices for precision control loops.

Loop Speed:

Many factors determine control loop speed. Typically, the conversion time of the ADC and the computation time of the MCU are the two major factors that dominate the time constant of the loop. DAC settling time is rarely a dominant factor because ADC conversion times usually exceed DAC conversion times. DAC offset, gain, and linearity errors can slow the loop down only during the start-up. Once the loop reaches its steady-state operation, these errors do not affect loop speed any further. Depending on the ringing characteristics of the loop's transfer function, DAC glitches can also slow the loop down. With its 1 MSPS (small-signal) maximum data update rate, DAC7553 can support high-speed control loops. Ultralow glitch energy of the DAC7553 significantly improves loop stability and loop settling time.

Generating Industrial Voltage Ranges:

For control loop applications, DAC gain and offset errors are not important parameters. This could be exploited to lower trim and calibration costs in a high-voltage control circuit design. Using an operational amplifier (OPA130), and a voltage reference (REF3140), the DAC7553 can generate the wide voltage swings required by the control loop.

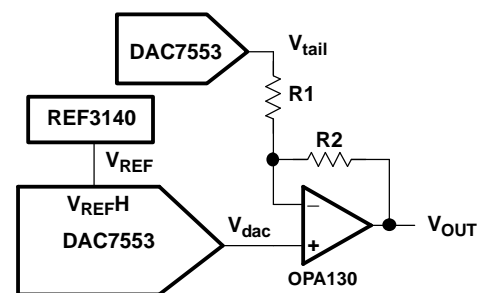

Figure 31. Low-cost, Wide-swing Voltage Generator for Control Loop Applications

The output voltage of the configuration is given by:

$$V_{\text{out}} = V_{\text{REF}} \left(\frac{R2}{R1} + 1 \right) \frac{D_{\text{in}}}{4096} - V_{\text{tail}} \frac{R2}{R1} \quad (1)$$

Fixed R1 and R2 resistors can be used to coarsely set the gain required in the first term of the equation. Once R2 and R1 set the gain to include some minimal over-range, a DAC7553 channel could be used to set the required offset voltage. Residual

errors are not an issue for loop accuracy because offset and gain errors could be tolerated. One DAC7553 channel can provide the V_{tail} voltage, while the other DAC7553 channel can provide V_{dac} voltage to help generate the high-voltage outputs.

For ± 5 -V operation: R1=10 k Ω , R2 = 15 k Ω , $V_{\text{tail}} = 3.33$ V, $V_{\text{REF}} = 4.096$ V

For ± 10 -V operation: R1=10 k Ω , R2 = 39 k Ω , $V_{\text{tail}} = 2.56$ V, $V_{\text{REF}} = 4.096$ V

For ± 12 -V operation: R1=10 k Ω , R2 = 49 k Ω , $V_{\text{tail}} = 2.45$ V, $V_{\text{REF}} = 4.096$ V

PACKAGING INFORMATION

Orderable Device	Status ⁽¹⁾	Package Type	Package Drawing	Pins	Package Qty	Eco Plan ⁽²⁾	Lead/Ball Finish	MSL Peak Temp ⁽³⁾
DAC7553IRGTR	ACTIVE	QFN	RGT	16	3000	Green (RoHS & no Sb/Br)	CU NIPDAU	Level-3-260C-168 HR
DAC7553IRGTRG4	ACTIVE	QFN	RGT	16	3000	Green (RoHS & no Sb/Br)	CU NIPDAU	Level-3-260C-168 HR
DAC7553IRGTT	ACTIVE	QFN	RGT	16	250	Green (RoHS & no Sb/Br)	CU NIPDAU	Level-3-260C-168 HR
DAC7553IRGTTG4	ACTIVE	QFN	RGT	16	250	Green (RoHS & no Sb/Br)	CU NIPDAU	Level-3-260C-168 HR

⁽¹⁾ The marketing status values are defined as follows:

ACTIVE: Product device recommended for new designs.

LIFEBUY: TI has announced that the device will be discontinued, and a lifetime-buy period is in effect.

NRND: Not recommended for new designs. Device is in production to support existing customers, but TI does not recommend using this part in a new design.

PREVIEW: Device has been announced but is not in production. Samples may or may not be available.

OBSOLETE: TI has discontinued the production of the device.

⁽²⁾ Eco Plan - The planned eco-friendly classification: Pb-Free (RoHS), Pb-Free (RoHS Exempt), or Green (RoHS & no Sb/Br) - please check <http://www.ti.com/productcontent> for the latest availability information and additional product content details.

TBD: The Pb-Free/Green conversion plan has not been defined.

Pb-Free (RoHS): TI's terms "Lead-Free" or "Pb-Free" mean semiconductor products that are compatible with the current RoHS requirements for all 6 substances, including the requirement that lead not exceed 0.1% by weight in homogeneous materials. Where designed to be soldered at high temperatures, TI Pb-Free products are suitable for use in specified lead-free processes.

Pb-Free (RoHS Exempt): This component has a RoHS exemption for either 1) lead-based flip-chip solder bumps used between the die and package, or 2) lead-based die adhesive used between the die and leadframe. The component is otherwise considered Pb-Free (RoHS compatible) as defined above.

Green (RoHS & no Sb/Br): TI defines "Green" to mean Pb-Free (RoHS compatible), and free of Bromine (Br) and Antimony (Sb) based flame retardants (Br or Sb do not exceed 0.1% by weight in homogeneous material)

⁽³⁾ MSL, Peak Temp. -- The Moisture Sensitivity Level rating according to the JEDEC industry standard classifications, and peak solder temperature.

Important Information and Disclaimer:The information provided on this page represents TI's knowledge and belief as of the date that it is provided. TI bases its knowledge and belief on information provided by third parties, and makes no representation or warranty as to the accuracy of such information. Efforts are underway to better integrate information from third parties. TI has taken and continues to take reasonable steps to provide representative and accurate information but may not have conducted destructive testing or chemical analysis on incoming materials and chemicals. TI and TI suppliers consider certain information to be proprietary, and thus CAS numbers and other limited information may not be available for release.

In no event shall TI's liability arising out of such information exceed the total purchase price of the TI part(s) at issue in this document sold by TI to Customer on an annual basis.

TAPE AND REEL INFORMATION



QUADRANT ASSIGNMENTS FOR PIN 1 ORIENTATION IN TAPE



*All dimensions are nominal

Device	Package Type	Package Drawing	Pins	SPQ	Reel Diameter (mm)	Reel Width W1 (mm)	A0 (mm)	B0 (mm)	K0 (mm)	P1 (mm)	W (mm)	Pin1 Quadrant
DAC7553IRGTR	QFN	RGT	16	3000	330.0	12.4	3.3	3.3	1.1	8.0	12.0	Q2
DAC7553IRGTT	QFN	RGT	16	250	330.0	12.4	3.3	3.3	1.1	8.0	12.0	Q2

TAPE AND REEL BOX DIMENSIONS



*All dimensions are nominal

Device	Package Type	Package Drawing	Pins	SPQ	Length (mm)	Width (mm)	Height (mm)
DAC7553IRGTR	QFN	RGT	16	3000	340.5	333.0	20.6
DAC7553IRGTT	QFN	RGT	16	250	340.5	333.0	20.6

THERMAL INFORMATION

This package incorporates an exposed thermal pad that is designed to be attached directly to an external heatsink. The thermal pad must be soldered directly to the printed circuit board (PCB). After soldering, the PCB can be used as a heatsink. In addition, through the use of thermal vias, the thermal pad can be attached directly to the appropriate copper plane shown in the electrical schematic for the device, or alternatively, can be attached to a special heatsink structure designed into the PCB. This design optimizes the heat transfer from the integrated circuit (IC).

For information on the Quad Flatpack No-Lead (QFN) package and its advantages, refer to Application Report, Quad Flatpack No-Lead Logic Packages, Texas Instruments Literature No. SCBA017. This document is available at www.ti.com.

The exposed thermal pad dimensions for this package are shown in the following illustration.

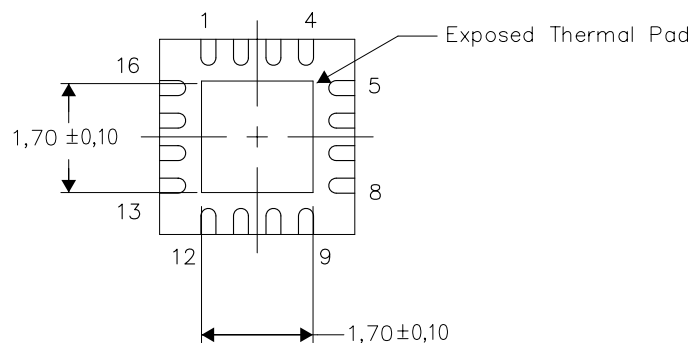

Bottom View

NOTE: All linear dimensions are in millimeters

Exposed Thermal Pad Dimensions

RGT (S-PQFP-N16)

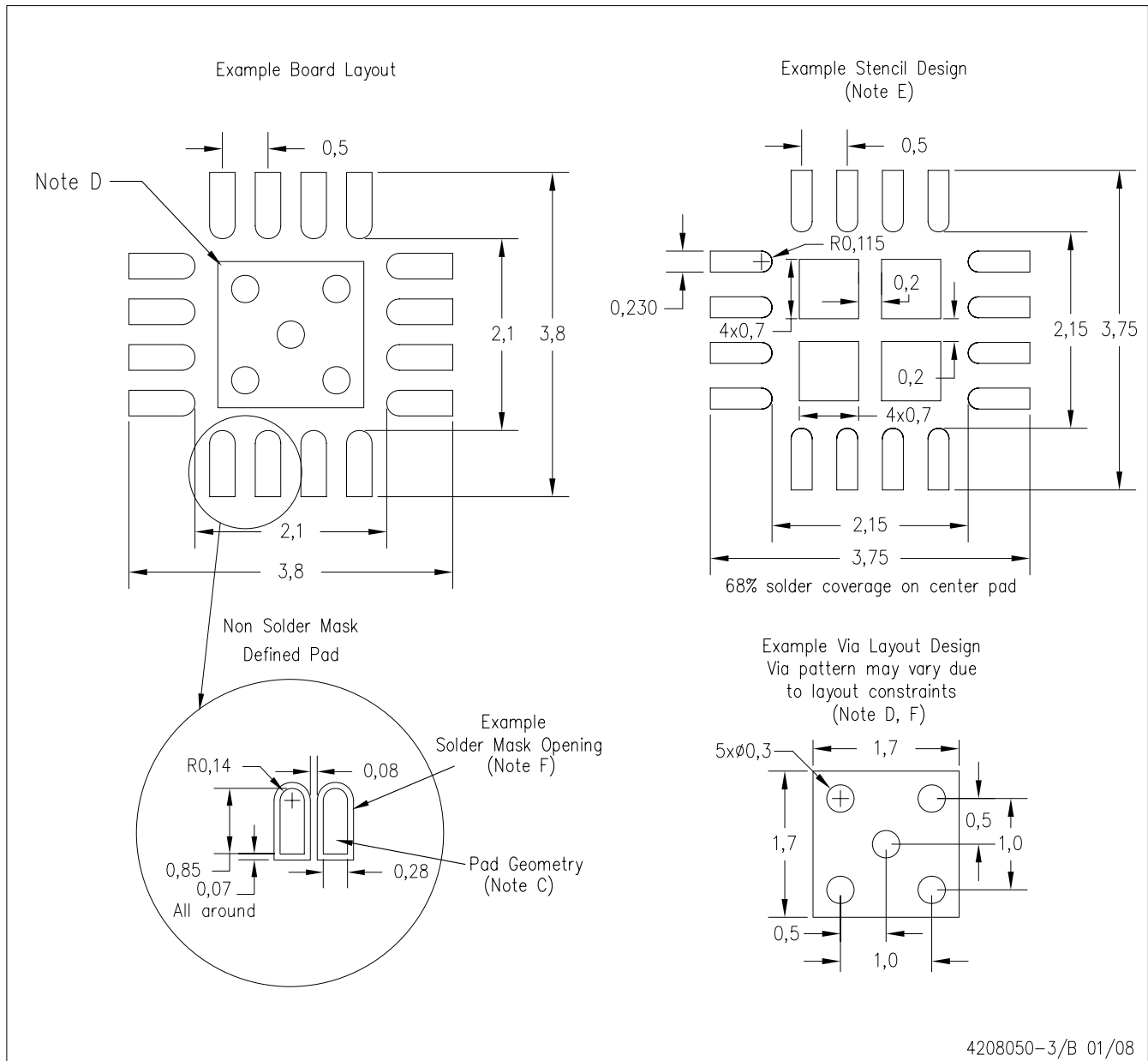

- NOTES:
- All linear dimensions are in millimeters.
 - This drawing is subject to change without notice.
 - Publication IPC-7351 is recommended for alternate designs.
 - This package is designed to be soldered to a thermal pad on the board. Refer to Application Note, Quad Flat-Pack Packages, Texas Instruments Literature No. SCBA017, SLUA271, and also the Product Data Sheets for specific thermal information, via requirements, and recommended board layout. These documents are available at www.ti.com <<http://www.ti.com>>.
 - Laser cutting apertures with trapezoidal walls and also rounding corners will offer better paste release. Customers should contact their board assembly site for stencil design recommendations. Refer to IPC 7525 for stencil design considerations.
 - Customers should contact their board fabrication site for minimum solder mask web tolerances between signal pads.

IMPORTANT NOTICE

Texas Instruments Incorporated and its subsidiaries (TI) reserve the right to make corrections, modifications, enhancements, improvements, and other changes to its products and services at any time and to discontinue any product or service without notice. Customers should obtain the latest relevant information before placing orders and should verify that such information is current and complete. All products are sold subject to TI's terms and conditions of sale supplied at the time of order acknowledgment.

TI warrants performance of its hardware products to the specifications applicable at the time of sale in accordance with TI's standard warranty. Testing and other quality control techniques are used to the extent TI deems necessary to support this warranty. Except where mandated by government requirements, testing of all parameters of each product is not necessarily performed.

TI assumes no liability for applications assistance or customer product design. Customers are responsible for their products and applications using TI components. To minimize the risks associated with customer products and applications, customers should provide adequate design and operating safeguards.

TI does not warrant or represent that any license, either express or implied, is granted under any TI patent right, copyright, mask work right, or other TI intellectual property right relating to any combination, machine, or process in which TI products or services are used. Information published by TI regarding third-party products or services does not constitute a license from TI to use such products or services or a warranty or endorsement thereof. Use of such information may require a license from a third party under the patents or other intellectual property of the third party, or a license from TI under the patents or other intellectual property of TI.

Reproduction of TI information in TI data books or data sheets is permissible only if reproduction is without alteration and is accompanied by all associated warranties, conditions, limitations, and notices. Reproduction of this information with alteration is an unfair and deceptive business practice. TI is not responsible or liable for such altered documentation. Information of third parties may be subject to additional restrictions.

Resale of TI products or services with statements different from or beyond the parameters stated by TI for that product or service voids all express and any implied warranties for the associated TI product or service and is an unfair and deceptive business practice. TI is not responsible or liable for any such statements.

TI products are not authorized for use in safety-critical applications (such as life support) where a failure of the TI product would reasonably be expected to cause severe personal injury or death, unless officers of the parties have executed an agreement specifically governing such use. Buyers represent that they have all necessary expertise in the safety and regulatory ramifications of their applications, and acknowledge and agree that they are solely responsible for all legal, regulatory and safety-related requirements concerning their products and any use of TI products in such safety-critical applications, notwithstanding any applications-related information or support that may be provided by TI. Further, Buyers must fully indemnify TI and its representatives against any damages arising out of the use of TI products in such safety-critical applications.

TI products are neither designed nor intended for use in military/aerospace applications or environments unless the TI products are specifically designated by TI as military-grade or "enhanced plastic." Only products designated by TI as military-grade meet military specifications. Buyers acknowledge and agree that any such use of TI products which TI has not designated as military-grade is solely at the Buyer's risk, and that they are solely responsible for compliance with all legal and regulatory requirements in connection with such use.

TI products are neither designed nor intended for use in automotive applications or environments unless the specific TI products are designated by TI as compliant with ISO/TS 16949 requirements. Buyers acknowledge and agree that, if they use any non-designated products in automotive applications, TI will not be responsible for any failure to meet such requirements.

Following are URLs where you can obtain information on other Texas Instruments products and application solutions:

Products

Amplifiers	amplifier.ti.com
Data Converters	dataconverter.ti.com
DSP	dsp.ti.com
Clocks and Timers	www.ti.com/clocks
Interface	interface.ti.com
Logic	logic.ti.com
Power Mgmt	power.ti.com
Microcontrollers	microcontroller.ti.com
RFID	www.ti-rfid.com
RF/IF and ZigBee® Solutions	www.ti.com/lprf

Applications

Audio	www.ti.com/audio
Automotive	www.ti.com/automotive
Broadband	www.ti.com/broadband
Digital Control	www.ti.com/digitalcontrol
Medical	www.ti.com/medical
Military	www.ti.com/military
Optical Networking	www.ti.com/opticalnetwork
Security	www.ti.com/security
Telephony	www.ti.com/telephony
Video & Imaging	www.ti.com/video
Wireless	www.ti.com/wireless

Mailing Address: Texas Instruments, Post Office Box 655303, Dallas, Texas 75265
Copyright © 2008, Texas Instruments Incorporated